

Article number: 2031100M24125B2U

Description: E+G levelling foot
GN 31-100-M24-125-B2-U

Note: U Without nut, Hexagon socket at the top, Wrench flat at the bottom

Measures

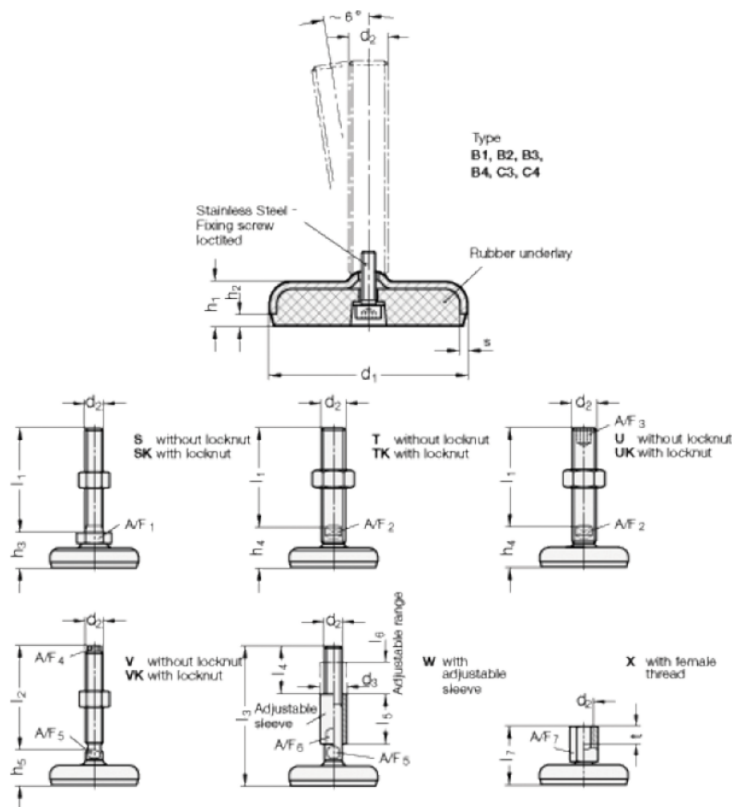

A/F2	= 19	s = 3
A/F3	= 12	
d1	= 100	
d2	= 24	
h1	= 20	
h4 +4.0/0	= 38	
l1	= 125	